

## Operating Instructions

# FORCED-ACTION MIXER COLLOMATIC XM 2-650

(110 VAC/60 hz - US)



Collomix GmbH  
Daimlerstraße 9  
85080 Gaimersheim  
Germany  
Telefon: +49 8458 3298-0  
[www.collomix.com](http://www.collomix.com)

**This manual must accompany the equipment at all times**

**⚠ WARNING**



**SILICOSIS WARNING**

Grinding/cutting/drilling of masonry, concrete, metal and other materials with silica in their composition may give off dust or mists containing crystalline silica. Silica is a basic component of sand, quartz, brick clay, granite and numerous other minerals and rocks. Repeated and/or substantial inhalation of airborne crystalline silica can cause serious or fatal respiratory diseases, including silicosis. In addition, California and some other authorities have listed respirable crystalline silica as a substance known to cause cancer. When cutting such materials, always follow the respiratory precautions mentioned above.

**⚠ WARNING**



**RESPIRATORY HAZARDS**

Grinding/cutting/drilling of masonry, concrete, metal and other materials can generate dust, mists and fumes containing chemicals known to cause serious or fatal injury or illness, such as respiratory disease, cancer, birth defects or other reproductive harm. If you are unfamiliar with the risks associated with the particular process and/or material being cut or the composition of the tool being used, review the material safety data sheet and/or consult your employer, the material manufacturer/supplier, governmental agencies such as OSHA and NIOSH and other sources on hazardous materials. California and some other authorities, for instance, have published lists of substances known to cause cancer, reproductive toxicity, or other harmful effects.

Control dust, mist and fumes at the source where possible. In this regard use good work practices and follow the recommendations of the manufacturers or suppliers, OSHA/NIOSH, and occupational and trade associations. Water should be used for dust suppression when wet cutting is feasible. When the hazards from inhalation of dust, mists and fumes cannot be eliminated, the operator and any bystanders should always wear a respirator approved by NIOSH/MSHA for the materials being used.

## Contents

	Page
<b>1. Layout</b>	<b>3</b>
1.1 Technical data	4
1.2 EC Declaration of Conformity	4
<b>2. Definitions of technical terms</b>	<b>5</b>
<b>3. Safety instructions</b>	<b>6</b>
3.1 Responsibility of the user	7
<b>4. Intended use</b>	<b>8</b>
4.1 Liability and warranty	8
<b>5. Transportation instructions</b>	<b>9</b>
5.1 Delivery	9
5.2 Moving the machine manually	9
<b>6. Disposal</b>	<b>9</b>
<b>7. Trolley</b>	<b>10</b>
7.1 Assembly	10
7.2 Handling	10
<b>8. Mixing tools</b>	<b>11</b>
8.1 Tooling options	11
8.2 Adjusting the height of the mixing tools	11
8.3 Changing the mixing tools.	11
8.4 Rim scraper	12
<b>9. Use of the correct mixing tub</b>	<b>12</b>
<b>10. Power connection</b>	<b>12</b>
<b>11. Using for the first time</b>	<b>13</b>
11.1 Opening and closing the machine	13
11.2 Switching on	13
11.3 Stopping	13
11.4 Setting the timer switch	14
<b>12. Description of the safety equipment</b>	<b>15</b>
12.1 Guard cage	15
12.2 Safety switch	15
12.3 Power switch / EMERGENCY STOP switch	15
<b>13. Troubleshooting</b>	<b>16</b>
<b>14. Care and maintenance</b>	<b>17</b>
<b>15. Annex</b>	<b>18</b>
15.1 Electrical circuit diagram	18
Exploded drawing of the trolley	19

# 1. Components

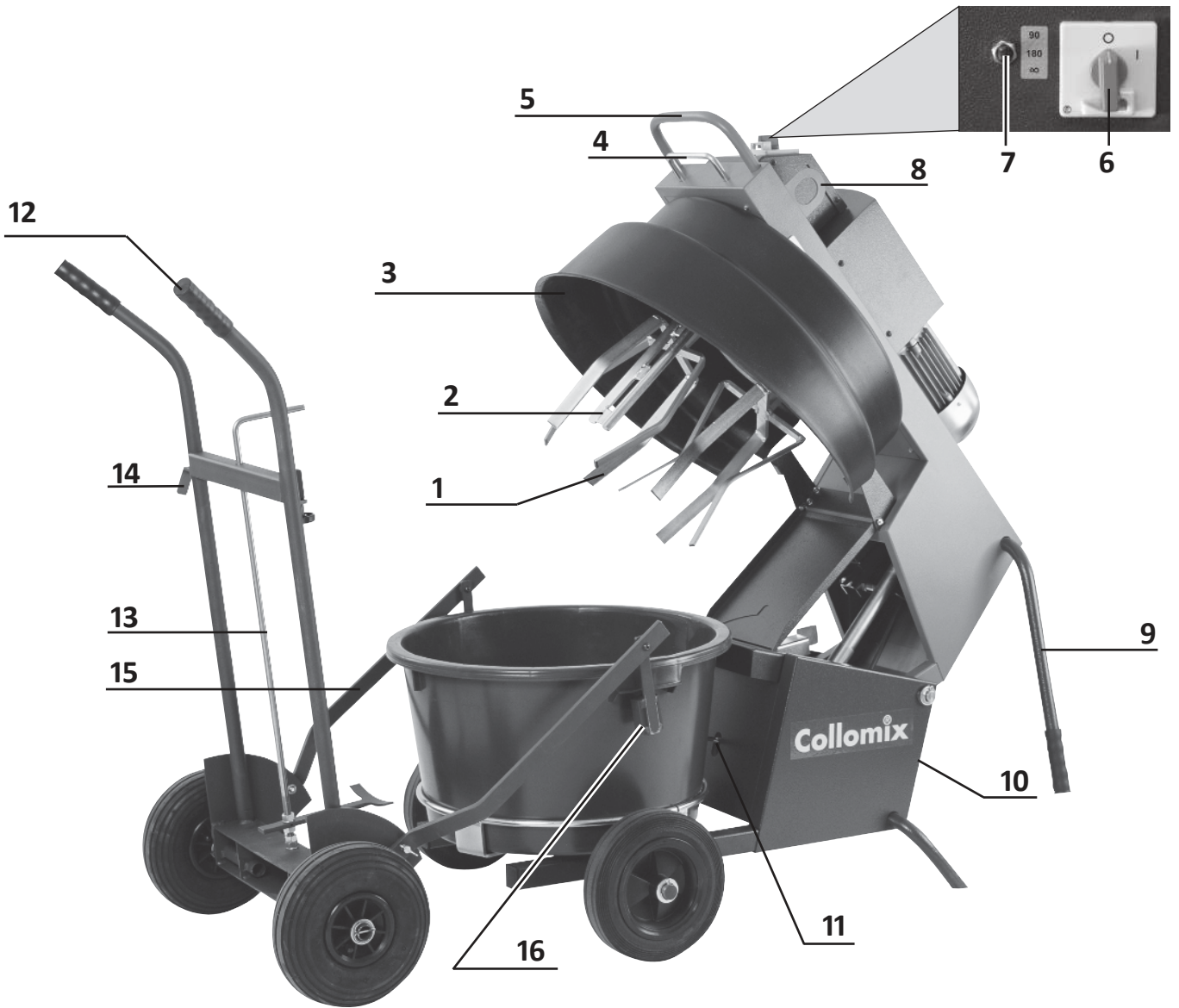

## Key to illustration

1. **Mixing tools** - Counter-rotates at optimum rpm to mix material. Paddles are changeable to accomodate thin and thick materials.
2. **Rim scraper** - Continuously moves around the rim of the tub and forces the materials back into the middle of the tub.
3. **Guard hood** - Protects the gear unit and the mixing tools from direct access. Hood has opening on top, with mesh guard, to allow operator to see the inside of the tub.
4. **Latch bar** - Releases the swivel arm when pulled out, to open and closed the mixer
5. **Handle** - to open the swivel arm when pulled up and closes the mixer when pulled down
6. **Main switch / EMERGENCY ON/OFF switch** - Switches the power on and off. The switch automatically jumps to the off positon in the event of undervoltage which prevents the machine from being started up again unintentionally.
7. **Timer switch** - Used to select mixing time of 90 sec., 180 sec. or continuous mixing mode.
8. **Eyelet for lashing (2x)** - Used to attach straps to secure the machine during transport.
9. **Carrier handles, lockable** - Used to hold the mixer and movie the machine on flat surfaces
10. **Cable plug** - to connect machine by using an accordingly extension cord with a 110 volts power supply.
11. **Control pin for the mixing tub** - Enables the mixer when a suitable tub is placed on the mixer. The control pin ensures that the mixer will not start without a tub in place.
12. **Tub Dolly (accessory)** - Recommended for lifting the tub out of the machine and to transporting it.
13. **Axle bar with tub stop** - Helps to fix the tub for emptying by turning the bar through 90°.
14. **Tub holder** - Also needed to lock the tub into positon for emptying with the dolly.
15. **Arms** - to be able to pick up the tub with the dolly,
16. **Tub mount** - floating mounted devices to place into the tub handles, for lifting the tub with the dolly



## 1.1 Technical data

Type:	<b>COLLOMATIC XM 2-650</b>
Power supply:	<b>110 volts AC / 21 amps</b>
Rated power:	1,5 hp / 60 hz
Fuse:	16 amps slow blow
Motor protection class:	IP 54
Tool speeds:	2 x 185 rpm 1 x 670 rpm
Rim scraper speed:	37 rpm
settable mixing times:	90 / 180 sec. / continuous run
Total weight:	231 lbs (105 kg)
Sound pressure level:	70 dB (A)
Sound power level:	< 85 dB (A)

**Manufacturer:**  
COLLOMIX GmbH  
Daimlerstr. 9,  
D-85080 Gaimersheim  
Telephone: +49 84 58 32 98-0  
e-Mail: [info@collomix.de](mailto:info@collomix.de)  
Web: [www.collomix.com](http://www.collomix.com)

**Contact North America:**  
Collomix North America  
PO.Box 13007  
Milwaukee, WI 53213  
262-207-4241  
[office@collomix.com](mailto:office@collomix.com)

## 1.2 EC Declaration of Conformity

We declare herewith that this product conforms with the following standards and standard-setting documents:  
EN 60204-1:2018, EN ISO 12100:2010, EN ISO 13849-1:2015, EN IEC 63000:2018; EN 55011:2016 + A1:2017 + A11:2020 + A2:2021;  
EN 61000-3-2:2019, EN 61000-3-3:2013+A1:2019, EN 61000-6-2:2019

Alexander Essing  
President  
Collomix GmbH



## 2. Definitions of technical terms

**Forced-action mixer:**

a mixing unit with two or more rotating mixing tools, creating a counter-current material flow. Both tools and a rim scraper rotate simultan around the container center.

**Direction of rotation (only 3-phase units)**

describes the direction in which the motor and the mixing tools rotate.

**Limit switch**

an electric switch closed or opened by a moveable part.

**Explosive atmosphere**

is decribed by the amount of inflameable particles in the ambient room air, which will cause an explosion through heat, or sparks.

**FI-Breaker**

special marked a Ground Fault Circuit Interruptor, which interrupts the current.

**Extension cord marked "SJNW"**

a special type of rubber extension cord rated for outdoor use

**Rim scraper**

a rotating metal plate following the inside contour of the container thereby moving the material toward the mixing tools.

**Electrical receptacle**

point of power supply

**Threaded spindle**

connection for mixing tools

**rpm**

revolutions per minute

**Viscosity**

flow characteristic of liquids;      low viscosity      = thin liquids  
high viscosity      = thick or ropy liquids

**Electrical supply**



power cord



### 3. Safety messages

The four safety messages shown below will inform you about potential hazards that could injure you or others. The safety messages specifically address the level of exposure to the operator and are preceded by one of four words:

**DANGER, WARNING, CAUTION or NOTICE**

 <b>DANGER</b>
Indicates a hazardous situation which, if not avoided, <b>WILL</b> result in <b>DEATH</b> or <b>SERIOUS INJURY</b> .
 <b>WARNING</b>
Indicates a hazardous situation which, if not avoided, <b>COULD</b> result in <b>DEATH</b> or <b>SERIOUS INJURY</b>
 <b>CAUTION</b>
Indicates a hazardous situation which, if not avoided, <b>COULD</b> result in <b>MINOR</b> or <b>MODERATE INJURY</b>
<b>NOTICE</b>
Addresses practices not related to personal injury.



### 3. Safety instructions

#### **CAUTION**

This machine has been manufactured in accordance with the latest approved rules of technical practice applicable at the time of its development and production, and is safe to use. However, it may be the cause of danger if misused or used for any purpose other than that for which it is intended by persons who are not suitably qualified and trained. **The machine is therefore to be used and work of maintenance carried out only by persons who have read the operating instructions and who are acquainted with the occupational safety and accident prevention regulations in force in your country.**

- **Please read and observe these instructions before you work with the machine. There is a direct risk of personal injury or harm to the health of the user or third party if these instructions are not observed.** The notes and instructions are denoted by danger symbols in the text.
- Never use the machine if it is not in good working order, use it for the intended use only and have proper regard for safety and danger at all times. All faults which may impair safety must be rectified immediately!
- Wear close-fitting clothing and safety shoes when using the machine and never wear jewelry of any kind. Wear a hair net if you have long hair.
- Make sure the machine stands securely.
- The machine must always be operated and loaded from the front only.
- Never allow any third persons to stand within your working area.
- Never work in any way which could be unsafe.
- Comply with all electrical regulations applicable to the place of use when you set up the machine.



- **Always pull out the mains plug when not using the machine, before changing the mixing tool or before starting any maintenance work.**
- Never use the cable to pull the plug out of the socket outlet. Protect the cable from heat, oil and sharp edges.
- For outdoor use, use only cables which have been approved for the purpose and bear corresponding markings.
- Never connect the machine to household socket outlets. It may only be connected to special power outlets, e.g. distribution boards for construction sites with earth-leakage circuit-breakers.
- If a cable reel is used, the cable must be fully unwound. There is a risk of the cable catching fire from overheating. It can also cause a loss of power which will in turn trigger the undervoltage fuse.
- Before you switch on the machine, check that the tool wrench and any other objects have all been removed from the mixing tub.
- Never mix any materials with a flash point of below 70°F (21°C). Never use any solvents with a flash point of below 70°F (21°C) to clean the machine. Risk of explosion! Never use the machine in any areas where there is a potentially explosive atmosphere. Risk of explosion!
- Always make sure the machine is at a standstill before you ever take any material samples.
- **Do not operate the machine without the guard cage or without any of the parts of the housing. Risk of crushing!**
- **The consequence of deliberately shutting off any of the safety functions is an acute risk of accidents and injury.**
- Never use the trolley for any other purpose than for transporting the original Collomix mixing tub for which it is designed.
- Only open and close the machine with the handle provided. There is a risk of crushing if you attempt to open and close it at any other point.
- Always replace the gas-pressurized spring with a new one if it is defective. Never open the gas-pressurized spring as it is pressurized. Risk of injury!
- Make sure that the control pin moves without hindrance at all times and that the limit switch also works properly at all times. It is imperative that these never become soiled. A malfunction here may cause the mixing tools to start up unintentionally. Risk of crushing!
- If the machine is lifted by a crane or similar, the lifting ropes/cables or belts must only be fastened to the described points provided on the machine. Never stand under the suspended load.
- Use only original replacement parts.



### 3.1 Responsibility of the user

These Operating Instructions must be kept in close proximity to the machine and must be available to all persons working with or on the machine at all times.

Never use the machine if it is not in good working order or is not safe to use. Check that the machine is in proper working order every time before you start using it.

## 4. Intended use

The forced-action mixer is a mobile electric mixer. It has been designed for both outdoor and indoor use. It is designed for the mixing of both thin-bodied and heavy, viscous chemical building products such as wide variety of mortars, concrete (3/8" gravel size), cement, loam mortar, self-leveling over- and underlayments, epoxy-resin compounds, multi-component building materials and materials for fireproof and acidproof installations. The machine is designed for use by all the building and building-related trades and by specialist building contractors, as well as in industry in general.

**Any use which is over and above the intended use and/or which deviates from the intended use is not permitted and shall be deemed to be misuse.**

The machine is driven by an electric motor. The power is transmitted by means of a planetary gear unit. This converts the power into three different speeds and transmits the speeds to the mixing tools and the rim scraper. The speeds are as follows:

Rim scraper: 40 rpm Mixing tools: 2 x 150 rpm or: 1 x 150 rpm and 1 x 770 rpm

In the mixing tub 2 counter-rotating mixing tools are guided through the mixing material while rotating around their own axes and the middle of the gear unit at the same time. The rim scraper, which moves continuously around the rim of the container, forces the material back into the middle. This ensures that the material is mixed very quickly and thoroughly.

The trolley (accessory) is designed to enable the mixing tub to be easily loaded and unloaded by just one person. At the same time, thin-bodied material can be easily poured out using the pouring device on the trolley.

The numbers given in brackets in these Operating Instructions refer to the numbers in the layout on page 4.

### 4.1 Liability and warranty

Within the scope of the conditions of supply, the manufacturer issues a 12 month warranty which applies to single-shift operation and is counted from the date of initial start-up. It covers all defects arising from faulty material or workmanship. Please note that all warranty claims must be accompanied by a proof of purchase.

All essential warranty repair work must only be carried out by adequately trained service engineers or by third parties with express prior authorization from Collomix. The carrying out of unauthorized repairs may render the warranty null and void.

Please return any defective parts or machines carriage-paid to our factory. Collomix reserves the right to decide whether cost-free replacement of parts is applicable. Parts and labor covered by the warranty will be supplied free of charge. The warranty does not cover travel costs, expenses or possible overnight accommodation resulting from warranty repairs carried out off our premises.

Any further responsibility, with particular reference to damage claims, including foregone profit or other material losses on the part of the customer, is expressly excluded.

Warranty and liability claims for personal or material damages are excluded if attributable to one or more of the following causes:

- Incorrect operation of the machine, as defined in the Operating Instructions
- Damage caused by excessive accumulations of dirt and/or incorrect cleaning.
- Operation of the machine with defective safety and/or protection devices.
- Failure to observe the instructions in the Operating Instructions with respect to set-up, initial start-up, operation and maintenance of the machine.

## 5. Transportation instructions

### 5.1 Delivery

The machine is packed and delivered on a pallet. The machine has a net weight of 231 lbs (105 kg). The location of the machine's center of gravity is shown in the adjacent illustration.

Never attempt to move the machine off the pallet on your own. Seek the assistance of others or use hoisting equipment.

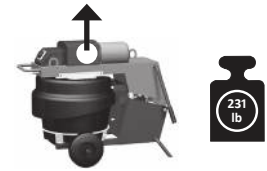

*Center of gravity of the machine*

### 5.2 Moving the machine manually

The machine is easy to move on all flat surfaces.

To do so, swing out the carrier handles and tighten using the thumb screw (see illustration). It is essential that the handles be fastened because when lifted the machine can tip forward, especially on an uneven surface (center of gravity).

Take hold of the carrier handles with both hands, lift and then move the machine as you would a wheelbarrow.

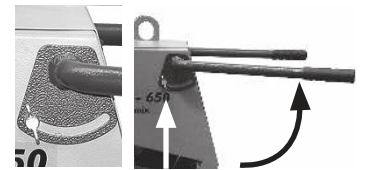

*How to move the machine manually*

## 6. Disposal

Where this is not possible, dismantle the parts and take to a responsible center for recycling.



## 7.0 Bucket Dolly (accessory)

The trolley (accessory) is designed for loading and unloading the mixing tub to and from the machine. At the same time the locking device on the trolley can be used to enable thin-bodied material to be poured out wherever it is required.

The trolley is supplied for 17 gals. tubs as standard.

### 7.1 Assembly of bucket dolly for 17 gal. tub

See extra manual for the bucket dolly.

First remove the two cable binders from the moving parts.

Fit the two handle ends and fasten each of them with a screw.

Tighten the two arms with the thumb screws.

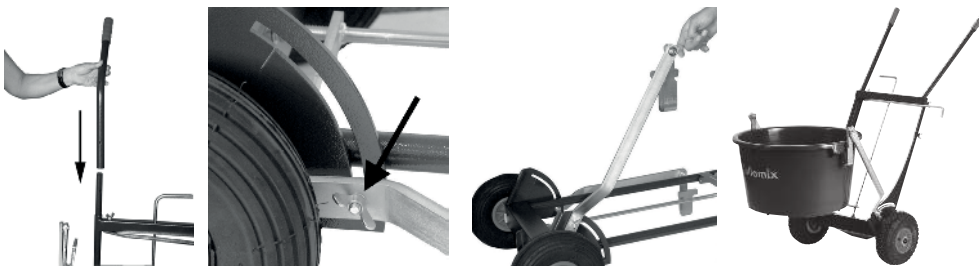

### 7.2 Handling of the bucket dolly

- Take hold of the trolley by both handles.
- Move the two tub mounts under the tub and hook them both into the two recessed handles on the tub.
- Press against the axle with one leg. Make sure that the tub is correctly in place.
- Tilt the trolley towards you until you have the tub in balance.
- If you are processing **thin-bodied materials** you can pour them by applying the locking device:
- Pick up the tub as described above. Then set the trolley down lengthwise on the floor. The tub swings free.
- First set the tub stop to vertical. The hook on the tub holder extends over the edge of the tub and holds it.
- Then turn the tub holder so that its handle is positioned vertically upwards. The tub is now locked.
- Now lift the trolley again slowly. As soon as you have reached a certain angle the material will flow out of the tub.
- Once you have finished pouring, set the trolley down again and release the tub holder and tub stop.

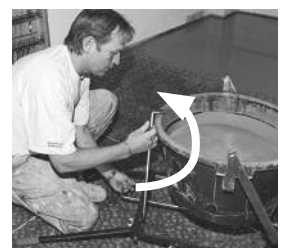

Using the pouring device

## 8. Mixing tools

Your forced-action mixer comes with three different mixing tools (Standard: universal mixing tools and a star-type mixing tool). These will enable you to mix materials of all viscosities.

### 8.1 Tooling options

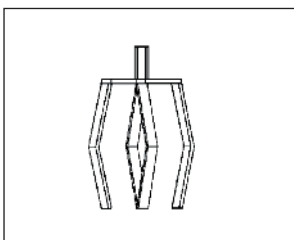

Universal mixing tool  
XM 160 (70153)

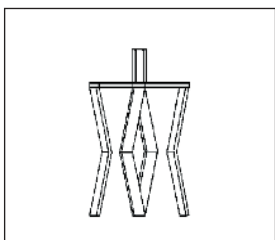

Universal mixing tool  
XM 195 (70155)

Both mixing tools rotate at a speed of 185 rpm. Use this tooling option for mixing all high-viscosity, viscous and heavy materials such as, for example.

- Ready-mixed mortar
- Quartz-filled epoxy-resins
- Industrial flooring
- Fireproof and acidproof materials
- Fillers
- Epoxy mortar
- Ceramic compounds
- Concrete
- 2-component and multi-component materials

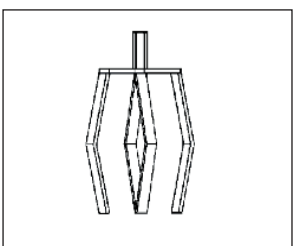

Universal mixing tool  
XM 160 (70153)

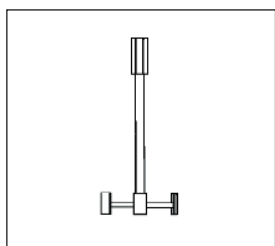

Dissolver ST 160 (70157)

This tooling option should be selected for the preparation of thin-bodied material or very light material which has a tendency to form lumps. The XM 160 rotates at a speed of 185 rpm and the Dissolver at 670 rpm, e.g.

- Self-leveling materials
- Flooring mixes
- Pouring mortars
- Multi-component materials
- Liquid plastics
- Grouting compounds
- Bonding agents

Three threaded spindles are available for the mixing tools. The two spindles for the universal mixing tools rotate at a speed of 185 rpm and have a size M 18 thread.

The third threaded spindle rotates at a speed of 670 rpm and is for the Dissolver. To ensure that this spindle is not fitted with the wrong tool it has a size M 16 thread.

#### **CAUTION**

**ALWAYS** disconnect the mixer from the power supply before cleaning, changing the mixing tool, or performing any maintenance

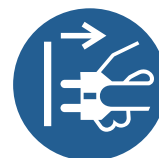

### 8.2 Adjusting the height of the mixing tools

In order to prevent deposits of residual material collecting at the bottom of the tub the mixing tools are height-adjustable. To adjust them, slacken the hexagon nut on drive spindle and move the mixing tool up or down as required by turning to the left or right.

The mixing tools should be approx. 1 - 2 mm above the bottom of the tub. If they are set too low they will scrape against the bottom of the tub and damage it beyond repair.

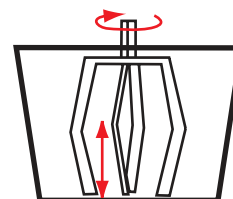

Adjusting the height of the mixing tools.

### 8.3 Changing the mixing tools

The mixing tools are fitted and adjusted at the factory. To remove them, loosen the locking nut slightly with an open-ended wrench while holding the mixing tool with a second open-ended wrench

Unscrew the mixing tool.

If you are not going to replace the tool with another one, screw the threaded plug onto the threaded spindle to prevent it from getting soiled. Remember to take account of the different thread sizes, M 16 and M 18.

When you screw a mixing tool to the spindle, always check the distance between the tool and the bottom of the tub. The tool must never come into contact with the bottom of the tub! Then retighten the locking nut against the mixing tool.

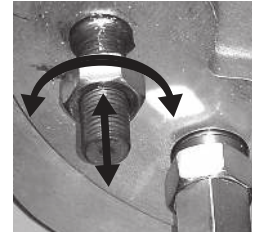

### 8.4 Rim scraper

The rim scraper is adjusted at the factory. If you readjust it you must take care to ensure that the arm of the rim scraper does not scrape against the rim of the tub.

Adjust the rim scraper so that it is as close as possible to the rim and bottom of the tub. However, it must not be in contact with these surfaces. Use the hexagon nut to make the adjustments.



## 9. Use of the correct mixing tub

For guaranteed trouble-free operation and consistently satisfactory mixing results it is important that you use the original mixing tub.

This is a round 17 gallon plastic tub made of impact-resistant PE material.

Tubs made by other manufacturers do not normally have the same dimensions and this will prevent the rim scraper from working properly. If a higher tub is used it may not be possible to close the machine.

Please contact your local dealer for the right original tub.

The machine will not start up unless the mixing tub is in place!



## 10. Power connection

Prior to any electrical connections of the machine - follow these instructions.

Observe any electrical safety precautions, which are mandatory at the place of operation.

At building sites use the approved electrical supply, with FI-breaker and 0,05 Amp. fault current. Do not connect to common house outlets.

Make sure, to prevent accidental damage to cables und electrical components.

Rubber cables of the type SJNW 3 x 13 AWG and proper connector must be used.

Unroll the full length of cable from the cable drum, to prevent built-up of heat, cable damage, electric shock, fire and production fall out.

Extreme long cables lead to voltage drop.

Keep cables away from traffic areas.

### Important note:

110 volt machines are delivered with supply cable without electric plug! Make sure that the corresponding plug is installed by an approved electrician.





## 11. Using for the first Time

### 11.1 Opening and closing the machine

- Take hold of the handle and the latch bar. Pull them towards you. This opens the lock.
- Pull the swivel arm upwards.
- The machine now stands open in front of you. In the mixing tub you will find two open-ended wrenches and one other tool. Take these out and check that the tub is empty.
- To close the machine, actuate the latch bar again as described above.
- Press the swivel arm down.
- Release the latch bar while doing so. It will lock into place on its own.



### 11.2 Switching on

- The machine must be open.
- The mixing tub must be filled and positioned in the machine with the help of the trolley. The tub must sit correctly in the tub mount.
- Switch the power switch to "1".
- Unlock the swivel arm and press it down until it locks.

**For the 3-phase version:** Observe the direction of rotation indicated by the arrow.

If the machine is disconnected from the mains power supply while closed, it has to be fully opened and then closed again. Then the machine will run again.

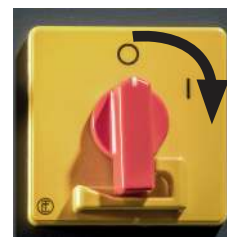

Switching on the power switch

### 11.3 Stopping

**When the set time cycle has been completed** the machine switches off automatically. **The power switch remains at "1"**. If you close the machine again the set time cycle will start running again from the beginning.

If "**Continuous mode**" is set the machine will stop when it is opened, or it has to be **switched off manually**. To do so, switch the power switch from "1" to "0".

If you open the swivel arm **while mixing is in progress the machine will stop immediately**. **The power switch remains at "1"**. The machine will start up again when you close the swivel arm. If a time cycle has been set it will start running again at the beginning.

After opening you should then remove the mixing tub with the help of the trolley.

#### NOTE:

Please follow the manufacturer's processing instructions.

Never start the machine if there is any hardened material in the mixing tub or if any of the mixing tools are jammed.

Always make sure the machine is at a total standstill before you ever take any material samples.



## 11.4 Setting the timer switch

The timer switch is situated on the front panel of the machine.

- |                       |   |
|-----------------------|---|
| „90“ position         | The mixing tools run for 90 seconds before switching off automatically  |
| „180“ position        | The mixing tools run for 180 seconds before switching off automatically |
| „Continuous“ position | For switching on/off by hand; no automatic function                     |



### NOTE:

Whenever you mix any previously unfamiliar materials, determine the time required for mixing when you mix them for the first time. By setting the correct mixing time you will achieve evenly and thoroughly mixed material every time.

## 12. Description of the safety equipment

The safety devices previously referred to have been integrated in the machine for your personal safety and the safety of others. Make sure that these are in full working order at all times. Never start the machine if any safety devices are defective. Anyone who deliberately removes any safety devices or renders them inoperative is liable to prosecution. Such an action would cause incalculable danger for the user. At the same time this would also render the warranty for the machine null and void.

### 12.1 Guard cage

The gear unit and the mixing tools are protected from direct access by a guard cage which is fixed firmly to the frame of the machine. The mixing tools start to run before the machine is fully closed. The remaining gap between the swivel arm and the top edge of the tub is covered by the guard cage. In addition, we should also advise that it is not permitted to reach into the area between the guard cage and the tub while the machine is being closed or opened. The guard cage has an opening on the top, covered by a mesh guard, to enable you to see into the tub.

### 12.2 Safety switch

The machine is switched to enable status by the control pin, via a limit switch, as soon as a suitable tub is in the machine. The machine will not start without a tub in place. Make sure that the control pin moves freely at all times and make sure that it never becomes soiled. Bridging the switch or pressing it by hand without a tub in the machine is not permitted

### 12.3 Power switch/EMERGENCY STOP switch with undervoltage release

The power switch is also an EMERGENCY STOP switch at the same time and has an undervoltage release. Switch the switch to "0". This switches the machine completely off. The undervoltage release is for ensuring that the switch automatically jumps to "0" in the event of undervoltage. The main purpose of this is to prevent the machine from being started up again unintentionally.

This can be the case in the following situations:

- In the event of a power failure
- If the cable is pulled from the plug
- In the event of a power failure in the mains power supply
- If the drive unit overheats Allow the drive unit to cool down and then try to restart. Reduce the amount of mixing material if necessary.

## 13. Troubleshooting

Symptom	Possible Problem	Solution
<b>Mixer does not start</b>	ON/OFF switch is set manually to "0"	Open the mixer, set ON/OFF switch to "1" and close the mixer again
	Cable too long and/or cable cross-section not large enough	Check cable cross-section; must be 2.5 mm <sup>2</sup> . Reduce cable length.
	Plug not connected?	Check if plugs are connected
	No power from main power supply?	Check main power supply
	No mixing tub in the machine?	Insert mixing tub correctly
	Incorrect mixing tub in mixer?	Use the correct model of mixing tub
	Defective start-up capacitor ( <b>110 V only</b> )	Replace the start-up capacitor
	Defective operating capacitor ( <b>110 V only</b> )	Replace the operating capacitor
<b>Machine turns off after a short time and cannot be restarted</b>	Bimetal element triggered (machine overload)?	Allow the machine to cool down (min. 2 minutes); if necessary reduce the amount of mixing material
	Cable too long and/or cable cross-section not large enough?	Check cable cross-section; must be 2.5 mm <sup>2</sup> . Reduce cable length.
	Plug got disconnected?	Reconnect plug to power outlet
	Loss of power in the mains power supply?	Check the mains power supply
	Defective start-up capacitor ( <b>110V only</b> )	Replace the start-up capacitor
	Defective operating capacitor ( <b>110V only</b> )	Replace the operating capacitor
<b>Damage to the mixing tub or the mixing tools</b>	Mixing tools set too low	Set the mixing tools to the correct height (see Section 8.2)
<b>Deposits of residual material collecting at the bottom of the tub</b>	Mixing tools set too high or worn out	Check Mixing tools / set the mixing tools to the correct height (see Section 8.2)

## 14. Care and maintenance

### DANGER

- **NEVER** use any solvents or flammable substances to clean the machine.

### CAUTION

**ALWAYS** disconnect the mixer from the power supply before cleaning, changing the mixing tool, or performing any maintenance

- Follow these notes and instructions to ensure that your forced-action mixer machine has a long life and offers trouble-free service.
- Grease or oil all moving parts every **100 operating hours**. Check that all moving parts run smoothly.
- Clean the machine, mixing tools and the tub thoroughly every time you finish using them. A quick and easy method of cleaning the mixing tools is to tip in a bucket of clean sand or similar and then switch on the machine for approx. 30 seconds.
- Never use a **water hose or high-pressure cleaner** to clean the machine itself. This could cause the ball-bearings, etc., to run dry.
- Check the state of the mixing tools for wearing out.
- Replace all damaged or bent mixing tools.
- Make sure that the control pin moves without hindrance at all times and that the limit switch also works properly at all times. It is imperative that these never become soiled. Never start the machine if there are any faults or any obvious damage. All faults should only ever be repaired by a qualified expert.
- Use only original replacement parts.
- **Repairs should only be carried out by qualified experts.** The manufacturer also offers a repair service at its factory.

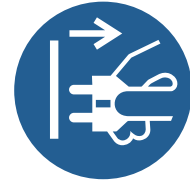

**15.1 Circuit diagram - 110 Volt, 60 Hz**

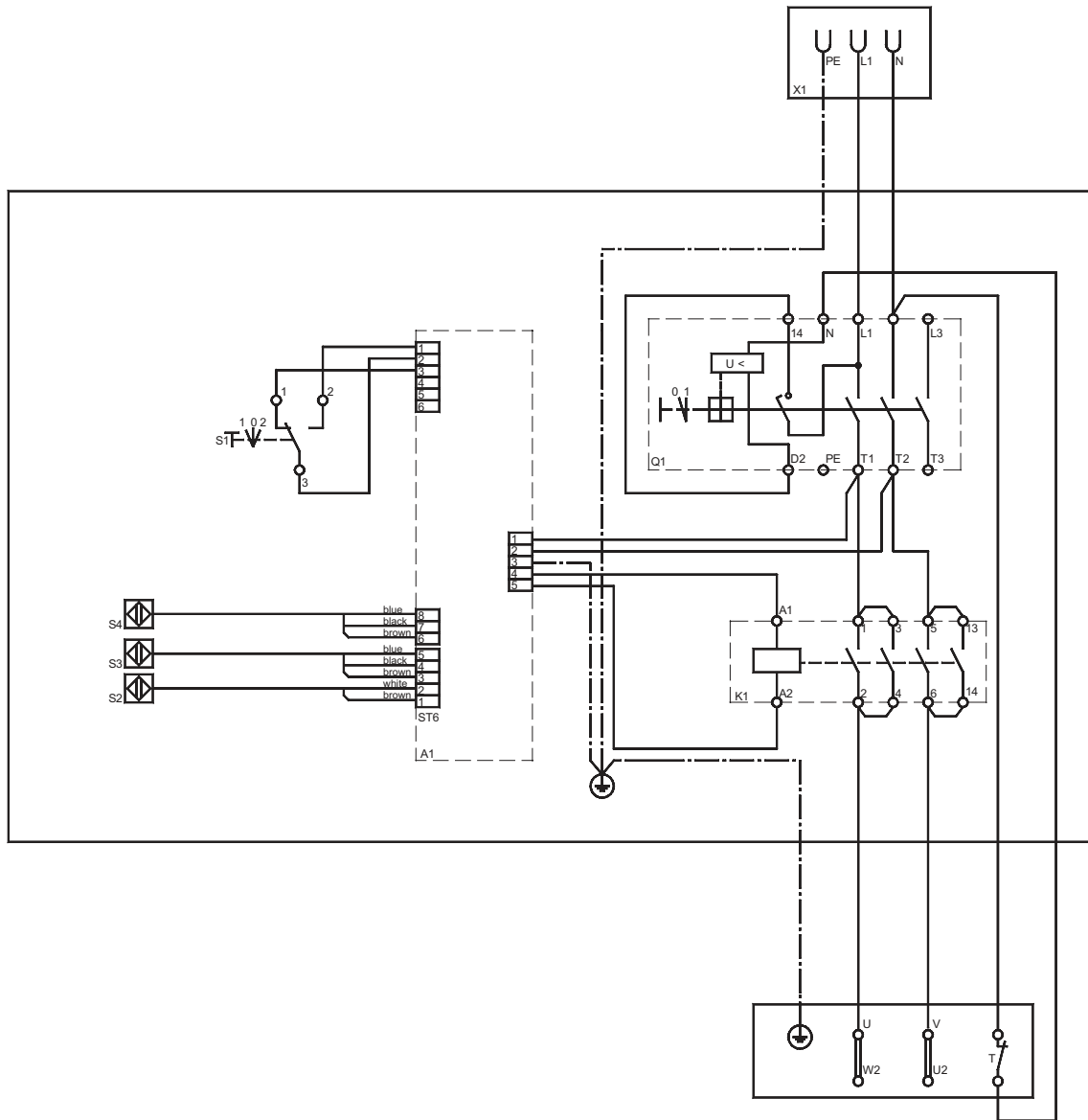

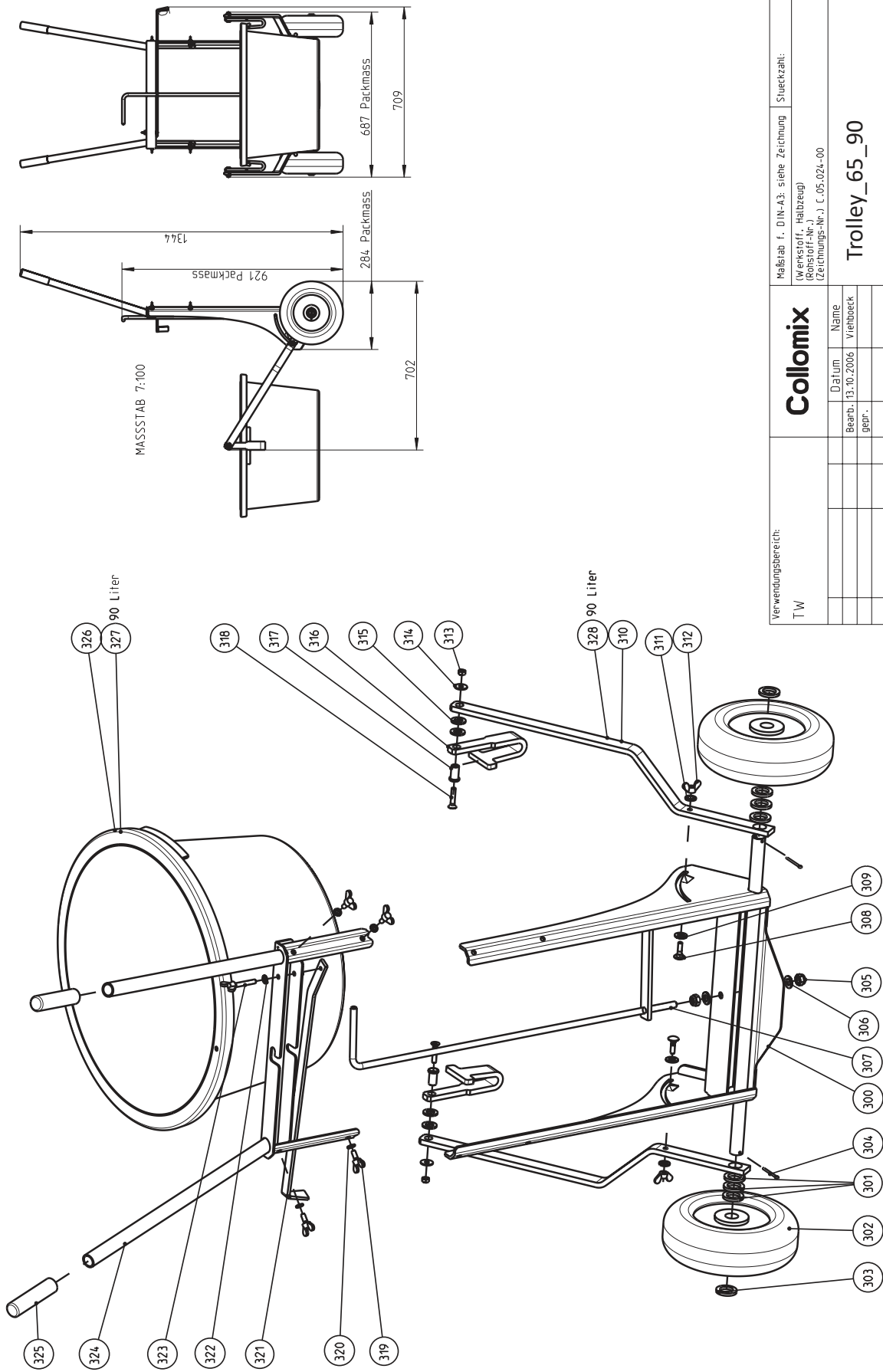

Verwendungsbereich: TW	Collomix		Maßstab f. DIN-A3: siehe Zeichnung		Stueckzahl:	
	(Werkstoff: Halbzeug)		(Zeichnungs-Nr.): C.05.024-00			
	Datum	Name				
	Bearb. 13.10.2006	Vrenboeck				
	gepr.					
Zust.	Aenderung	Datum	Name	Ruehr- und Mischgeraete GmbH		
				Allg. Fertigungsmaerzzen nach DIN ISO 2768 m (Ausnahmen siehe Zeichnung)		
				Modellname: TRANSPORTWAGEN-MK2		
				Blatt 1 von 1 Bl.		
				Trolley_65_90		

